

**CHARGING
SOLUTION**

**HAWKER®
MODULAR
CHARGERS**

TECHNICAL DATA SHEET

“MODULAR: SETTING
A NEW STANDARD”

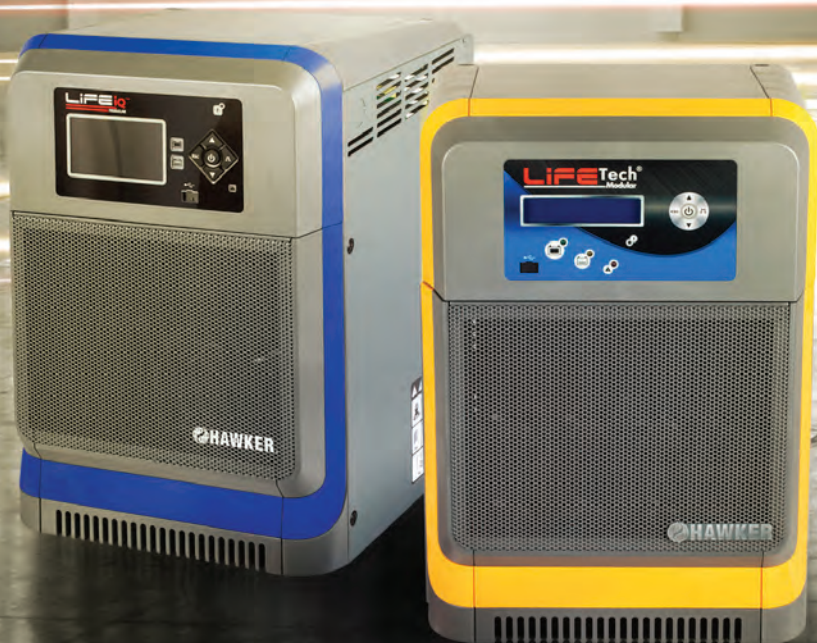

Lifetech® Modular

MATCHING TABLE OF CAPACITY AND RECHARGE TIME - SINGLE PHASE AND THREE PHASE

Charging Times (+/- 0.5 h) from 80% DOD at 30°C

CHARGING PROFILES	Configuration	Volt	Capacity (Ah)			Recharge Time (h)			Gel/Evolution (PzV, PzVB)		OPPORTUNITY CHARGE (PzQ)	
			C ₂ Min	C ₂	C ₂ Max	C ₂ Min	C ₂	C ₂ Max	C ₂ Min	C ₂ Max	C ₂ Min	C ₂ Max
Slow Charge PzS, PzB, PzM						9 h	10.5 h	12 h				
Heavy duty flooded PzS, PzB, PzQ			7 h	8 h	9 h				@60% 8 h	@60% 9 h		
Standard flooded PzS, PzB, PzM (WL8)			6 h	7 h	8 h				@80% 11 h	@80% 12 h		
Airmix with PzS, PzB, PzM (WL13), PzQ			5.5 h	6.5 h	7.5 h							

SINGLE PHASE

Model	Configuration	Volt	C ₂ Min	C ₂	C ₂ Max	C ₂ Min	C ₂	C ₂ Max	C ₂ Min	C ₂ Max	C ₂ Min	C ₂ Max
TC1 LT Modular 12V 1kW*	Contr POUT**	12	108	189	208	208	245	290	123	165	108	135
	MAX POUT		144	252	277	277	327	387	164	220	135	180
TC1 LT Modular 24V 1kW*	Contr POUT**	24	108	189	208	208	245	290	123	165	108	135
	MAX POUT		144	252	277	277	327	387	164	220	135	180
TC1 LT Modular 24V 2kW	Contr POUT**	24	196	343	377	377	445	527	223	300	180	245
	MAX POUT		288	503	554	554	655	774	327	440	245	360
TC1 LT Modular 24V 3kW	Contr POUT**	24	380	664	731	731	864	1022	432	581	360	475
	MAX POUT		432	755	831	831	982	1161	491	661	475	540
TC1 LT Modular 36/48V 1kW*	Contr POUT**	36	64	112	123	123	145	172	73	98	64	80
	MAX POUT		100	175	192	192	227	269	114	153	80	125
TC1 LT Modular 36/48V 2kW	Contr POUT**	36	136	238	262	262	309	366	155	208	125	170
	MAX POUT		192	336	369	369	436	516	218	294	170	240
TC1 LT Modular 36/48V 3kW	Contr POUT**	36	240	420	462	462	545	645	273	367	240	300
	MAX POUT		300	524	577	577	682	806	341	459	300	375
TC1 LT Modular 36/48V 1kW*	MAX POUT	48	72	126	138	138	164	194	82	110	72	90
	Contr POUT**		98	171	188	188	223	263	111	150	90	123
TC1 LT Modular 36/48V 2kW	MAX POUT	48	144	252	277	277	327	387	164	220	123	180
	Contr POUT**		172	301	331	331	391	462	195	263	180	215
TC1 LT Modular 36/48V 3kW	MAX POUT	48	216	378	415	415	491	581	245	330	215	270
	Contr POUT**											

THREE PHASE

Model	Configuration	Volt	C ₂ Min	C ₂	C ₂ Max	C ₂ Min	C ₂	C ₂ Max	C ₂ Min	C ₂ Max	C ₂ Min	C ₂ Max
TC3 LT Modular 24/36/48V 3.5kW	MAX POUT	24	280	490	538	538	636	753	318	428	280	350
	Contr POUT**		384	671	738	738	873	1032	436	587	350	480
TC3 LT Modular 24/36/48V 7kW	Contr POUT1**	24	512	895	985	985	1164	1376	582	783	480	640
	MAX POUT		560	979	1077	1077	1273	1505	636	856	640	700
TC3 LT Modular 24/36/48V 10.5kW	Contr POUT**	24	652	1140	1254	1254	1482	1753	741	997	700	815
	MAX POUT		840	1469	1615	1615	1860		955	1120	815	1050
TC3 LT Modular 24/36/48V 14kW	MAX POUT	24	1120	1958	2064	1860					1050	1400
	MAX POUT		1280	2064							1280	1600
TC3 LT Modular 24/36/48V 21kW	MAX POUT	24	1280	2064							1280	1600
	MAX POUT											
TC3 LT Modular 24/36/48V 3.5kW	MAX POUT	36	260	455	500	500	591	699	295	398	260	325
	MAX POUT		520	909	1000	1000	1182	1398	591	765	325	650
TC3 LT Modular 24/36/48V 7kW	MAX POUT	36	780	1364	1500	1500	1773	1860	886	1120	650	975
	MAX POUT		1040	1818	2000						975	1300
TC3 LT Modular 24/36/48V 17.5kW	MAX POUT	36	1280	2064							1280	1600
	MAX POUT		1280	2064							1280	1600
TC3 LT Modular 24/36/48V 3.5kW	MAX POUT	48	240	420	462	462	545	645	273	367	240	300
	Contr POUT**		328	573	631	631	745	882	373	502	300	410
TC3 LT Modular 24/36/48V 7kW	Contr POUT1**	48	440	769	846	846	1000	1183	500	673	410	550
	MAX POUT		480	839	923	923	1091	1290	545	734	550	600
TC3 LT Modular 24/36/48V 10.5kW	Contr POUT**	48	560	979	1077	1077	1273	1505	636	856	600	700
	MAX POUT		720	1259	1385	1385	1636	1860	818	1101	700	900
TC3 LT Modular 24/36/48V 14kW	MAX POUT	48	960	1678	1846				1091	1120	900	1200
	MAX POUT		1200	2064							1200	1500
TC3 LT Modular 24/36/48V 21kW	MAX POUT	48	1280	2064							1280	1600
	MAX POUT											
TC3 LT Modular 72/80V 3.5kW	MAX POUT	72	160	280	308	308	364	430	182	245	160	200
	Contr POUT**		240	420	462	462	545	645	273	367	200	300
TC3 LT Modular 72/80V 7kW	MAX POUT	72	320	559	615	615	727	860	364	489	300	400
	Contr POUT**		400	699	769	769	909	1075	455	612	400	500
TC3 LT Modular 72/80V 10.5kW	MAX POUT	72	480	839	923	923	1091	1290	545	734	500	600
	MAX POUT		640	1119	1231	1231	1455	1720	727	979	600	800
TC3 LT Modular 72/80V 14kW	MAX POUT	72	800	1399	1538	1538	1818	1860	909	1120	800	1000
	MAX POUT		960	1678	1846	1846	1860		1091	1120	960	1200
TC3 LT Modular 72/80V 3.5kW	MAX POUT	80	144	252	277	277	327	387	164	220	144	180
	MAX POUT		288	503	554	554	655	774	327	440	180	360
TC3 LT Modular 72/80V 7kW	Contr POUT**	80	360	629	692	692	818	968	409	550	360	450
	MAX POUT		432	755	831	831	982	1161	491	661	450	540
TC3 LT Modular 72/80V 14kW	MAX POUT	80	576	1007	1108	1108	1309	1548	655	881	540	720
	MAX POUT		720	1259	1385	1385	1636	1860	818	1101	720	900
TC3 LT Modular 72/80V 21kW	MAX POUT	80	864	1510	1662	1662	1860		982	1120	864	1080
	MAX POUT											

* Airmix not available on 1 kW.

** Output currents set at different values to match specific capacities

Lifetech® Modular

TECHNICAL SPECIFICATION - SINGLE PHASE

Specifications	Units	Stand Alone 1kW **			2kW		3kW	
Battery voltage		12V	24V	36/48V	24V	36/48V	24V	36/48V
Nominal input voltage	Vac	230V +/- 10% / 1ph						
Frequency	Hz	50/60						
Max current draw @ 230Vac	Aac	2.4	4.8	5.1	9.6	10.2	14.4	15.3
AC input cable section	mm²	3 x 1.0			3 x 1.5			
AC input cable length	m	1.5						
Max output current @ 230Vac	Adc	36	36	25/18	72	50/36	108	75/54
Battery cables section	mm²	6			25			
Battery cables length	m	3						
IP protection		IP21						
Operating temperature	°C	0°C to +45°C						
Power factor		0.99						
Idle mode	W	≤10						
Display		2 line LCD						
Weight	kg	2.4			6.7		7.7	
Dimensions (HxWxD)	mm	264 x 148 x 96.5			344 x 250 x 182			
Weight with airmix	kg	** Not available on stand alone 1kW			10.0		11.0	
Dimensions (HxWxD) with airmix	mm	** Not available on stand alone 1kW			435 x 286 x 185			
Cabinet		1 bay stand alone			3 bay (2 modules)		3 bay (3 modules)	

1 bay stand alone

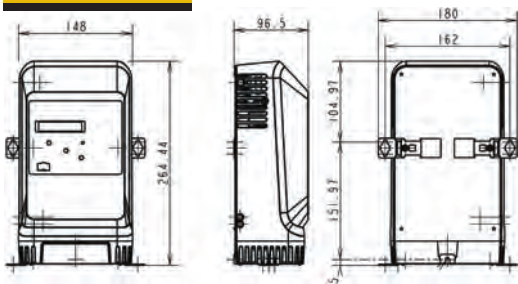

3 bay cabinet

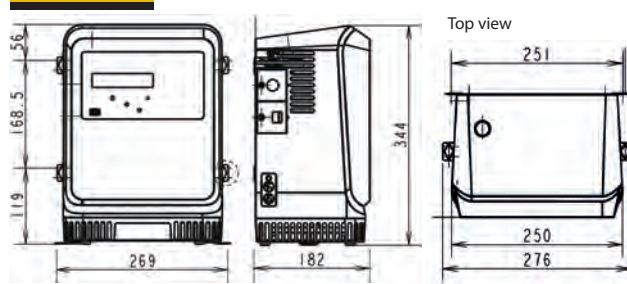

TECHNICAL SPECIFICATION - THREE PHASE

Specifications	Units	3.5kW		7kW		10.5kW		14kW		17.5kW		21kW	
Battery voltage		24/36/48V	72/80V	24/36/48V	72/80V	24/36/48V	72/80V	24/36/48V	72/80V	24/36/48V	72/80V	24/36/48V	72/80V
Nominal input voltage	Vac	400V +/- 10% / 3ph											
Frequency	Hz	50/60											
Max current draw @ 400Vac	Aac	5.6	5.6	11.2	11.2	16.8	16.8	22.4	22.4	28.0	28.0	29.8	33.6
AC input cable section	mm²	4 x 2.5				4 x 4.0				4 x 6.0			
AC input cable length	m	2											
Max output current @ 400Vac	Adc	70/65/60	40/36	140/130/120	80/72	210/195/180	120/108	280/260/240	160/144	320/320/300	200/180	320/320/320	240/216
Battery cables section	mm²	35				70				95			
Battery cables length	m	3											
IP protection		IP21											
Operating temperature	°C	0°C to +45°C											
Power factor		0.95											
Idle mode	W	≤10											
Display		2 line LCD											
Weight	kg	26.0	29.5	33.5	37.0	44.5	48.0						
Dimensions (HxWxD)	mm	508 x 335 x 352						508 x 485 x 352					
Weight with airmix	kg	28.0	31.5	35.5	39.0	46.5	50.0						
Dimensions (HxWxD) with airmix	mm	508 x 335 x 352						508 x 485 x 352					
Cabinet		2 bay (1 module)		2 bay (2 modules)		4 bay (3 modules)		4 bay (4 modules)		6 bay (5 modules)		6 bay (6 modules)	

2 and 4 bay cabinet

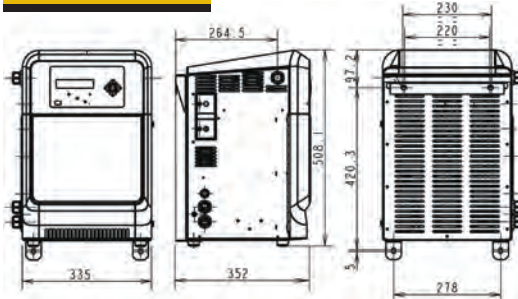

6 bay cabinet

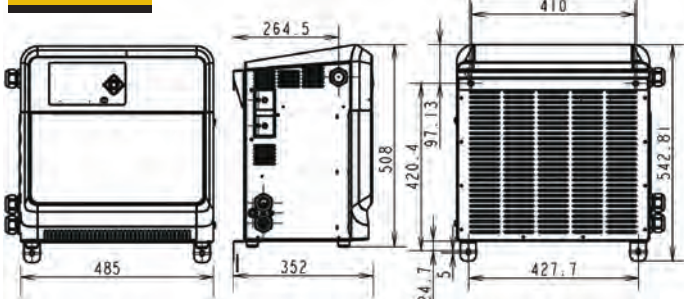

Life iQ™ Modular

MATCHING TABLE OF CAPACITY AND RECHARGE TIME - SINGLE PHASE AND THREE PHASE

Charging Times (+/- 0.5 h) from 80% DOD at 30°C

CHARGING PROFILES	Configuration	Volt	C ₂ Min		C ₂ Max		C ₃ Min		C ₃ Max		Gel/Evolution (PzV, PzVB)		OPPORTUNITY CHARGE (PzQ)	
			9 h	10.5 h	12 h	C ₂ Min	C ₂ Max	C ₃ Min	C ₃ Max	C ₂ Min	C ₂ Max	@60% 8 h	@60% 9 h	@80% 11 h
Slow Charge PzS, PzB, PzM														
Heavy duty flooded PzS, PzB, PzQ			7 h	8 h	9 h									
Standard flooded PzS, PzB, PzM (WL8)			6 h	7 h	8 h									
Airmix with PzS, PzB, PzM (WL13), PzQ			5.5 h	6.5 h	7.5 h									
Water Less™ 20 PzM								8h	10h	12h				

SINGLE PHASE

Model	Configuration	Volt	C ₂ Min	C ₂ Max	C ₃ Min	C ₃ Max	C ₂ Min	C ₂ Max	C ₃ Min	C ₃ Max	C ₂ Min	C ₂ Max	C ₃ Min	C ₃ Max	
TC1 LIQ Modular 24V 1kW	Contr POUT**	24	108	189	208	208	245	290	126	142	180	123	165	108	135
	MAX POUT		144	252	277	277	327	387	167	189	240	164	220	135	180
TC1 LIQ Modular 24V 2kW	Contr POUT**	24	196	343	377	377	445	527	228	258	327	223	300	180	245
	MAX POUT		288	503	554	554	655	774	335	379	480	327	440	245	360
TC1 LIQ Modular 24V 3kW	Contr POUT**	24	380	664	731	731	864	1022	442	500	633	432	581	360	475
	MAX POUT		432	755	831	831	982	1161	502	568	720	491	661	475	540
TC1 LIQ Modular 36/48V 1kW	Contr POUT**	36	64	112	123	123	145	172	74	84	107	73	98	64	80
	MAX POUT		100	175	192	192	227	269	116	132	167	114	153	80	125
TC1 LIQ Modular 36/48V 2kW	Contr POUT**	36	136	238	262	262	309	366	158	179	227	155	208	125	170
	MAX POUT		192	336	369	369	436	516	223	253	320	218	294	170	240
TC1 LIQ Modular 36/48V 3kW	Contr POUT**	36	240	420	462	462	545	645	279	316	400	273	367	240	300
	MAX POUT		300	524	577	577	682	806	349	395	500	341	459	300	375
TC1 LIQ Modular 36/48V 1kW	MAX POUT	48	72	126	138	138	164	194	84	95	120	82	110	72	90
	Contr POUT**		98	171	188	188	223	263	114	129	163	111	150	90	123
TC1 LIQ Modular 36/48V 2kW	MAX POUT	48	144	252	277	277	327	387	167	189	240	164	220	123	180
	Contr POUT**		172	301	331	331	391	462	200	226	287	195	263	180	215
TC1 LIQ Modular 36/48V 3kW	MAX POUT	48	216	378	415	415	491	581	251	284	360	245	330	215	270
	Contr POUT**														

THREE PHASE

Model	Configuration	Volt	C ₂ Min	C ₂ Max	C ₃ Min	C ₃ Max	C ₂ Min	C ₂ Max	C ₃ Min	C ₃ Max	C ₂ Min	C ₂ Max	C ₃ Min	C ₃ Max	
TC3 LIQ Modular 24/36/48V 3.5kW	MAX POUT	24	280	490	538	538	636	753	326	368	467	318	428	280	350
	Contr POUT**		384	671	738	738	873	1032	447	505	640	436	587	350	480
TC3 LIQ Modular 24/36/48V 7kW	Contr POUT**	24	512	895	985	985	1164	1376	595	674	853	582	783	480	640
	MAX POUT		560	979	1077	1077	1273	1505	651	737	933	636	856	640	700
TC3 LIQ Modular 24/36/48V 10.5kW	Contr POUT**	24	652	1140	1254	1254	1482	1753	758	858	1087	741	997	700	815
	MAX POUT		840	1469	1615	1615	1860	1860	977	1105	1400	955	1120	815	1050
TC3 LIQ Modular 24/36/48V 14kW	MAX POUT	24	1120	1958	2064				1302	1474	1860			1050	1400
	Contr POUT**		1280	2064						1488	1684	1860			1280
TC3 LIQ Modular 24/36/48V 21kW	MAX POUT	24	1280	2064					1488	1684	1860			1280	1600
	Contr POUT**														
TC3 LIQ Modular 24/36/48V 3.5kW	MAX POUT	36	260	455	500	500	591	699	302	342	433	295	398	260	325
	Contr POUT**		520	909	1000	1000	1182	1398	605	684	867	591	795	325	650
TC3 LIQ Modular 24/36/48V 7kW	MAX POUT	36	780	1364	1500	1500	1773	1860	907	1026	1300	886	1120	650	975
	Contr POUT**		1040	1818	2000				1209	1368	1733			975	1300
TC3 LIQ Modular 24/36/48V 14kW	MAX POUT	36	1280	2064					1488	1684	1860			1280	1600
	Contr POUT**		1280	2064						1488	1684	1860			1280
TC3 LIQ Modular 24/36/48V 3.5kW	MAX POUT	48	240	420	462	462	545	645	279	316	400	273	367	240	300
	Contr POUT**		328	573	631	631	745	882	381	432	547	373	502	300	410
TC3 LIQ Modular 24/36/48V 7kW	Contr POUT**	48	440	769	846	846	1000	1183	512	579	733	500	673	410	550
	MAX POUT		480	839	923	923	1091	1290	558	632	800	545	734	550	600
TC3 LIQ Modular 24/36/48V 10.5kW	Contr POUT**	48	560	979	1077	1077	1273	1505	651	737	933	636	856	600	700
	MAX POUT		720	1259	1385	1385	1636	1860	837	947	1200	818	1101	700	900
TC3 LIQ Modular 24/36/48V 14kW	MAX POUT	48	960	1678	1846				1116	1263	1600	1091	1120	900	1200
	Contr POUT**		1200	2064						1395	1579	1860			1200
TC3 LIQ Modular 24/36/48V 21kW	MAX POUT	48	1280	2064					1488	1684	1860			1280	1600
	Contr POUT**														
TC3 LIQ Modular 72/80V 3.5kW	MAX POUT	72	160	280	308	308	364	430	186	211	267	182	245	160	200
	Contr POUT**		240	420	462	462	545	645	279	316	400	273	367	200	300
TC3 LIQ Modular 72/80V 7kW	MAX POUT	72	320	559	615	615	727	860	372	421	533	364	489	300	400
	Contr POUT**		400	699	769	769	909	1075	465	526	667	455	612	400	500
TC3 LIQ Modular 72/80V 10.5kW	MAX POUT	72	480	839	923	923	1091	1290	558	632	800	545	734	500	600
	Contr POUT**		640	1119	1231	1231	1455	1720	744	842	1067	727	979	600	800
TC3 LIQ Modular 72/80V 14kW	MAX POUT	72	800	1399	1538	1538	1818	1860	930	1053	1333	909	1120	800	1000
	Contr POUT**		960	1678	1846				1116	1263	1600	1091	1120	960	1200
TC3 LIQ Modular 72/80V 3.5kW	MAX POUT	80	144	252	277	277	327	387	167	189	240	164	220	144	180
	Contr POUT**		288	503	554	554	655	774	335	379	480	327	440	180	360
TC3 LIQ Modular 72/80V 7kW	MAX POUT	80	360	629	692	692	818	968	419	474	600	409	550	360	450
	Contr POUT**		432	755	831	831	982	1161	502	568	720	491	661	450	540
TC3 LIQ Modular 72/80V 14kW	MAX POUT	80	576	1007	1108	1108	1309	1548	670	758	960	655	881	540	720
	Contr POUT**		720	1259	1385	1385	1636	1860	837	947	1200	818	1101	720	900
TC3 LIQ Modular 72/80V 21kW	MAX POUT	80	864	1510	1662	1662	1860		1005	1137	1440	982	1120	864	1080
	Contr POUT**														

* 3 Bay Cabinet | ** Output currents set at different values to match specific capacities

Life iQ™ Modular

TECHNICAL SPECIFICATION - SINGLE PHASE

Specifications	Units	1kW			2kW		3kW	
Battery voltage		12V	24V	36/48V	24V	36/48V	24V	36/48V
Nominal input voltage	Vac	230V +/- 10% / 1ph						
Frequency	Hz	50/60						
Max current draw @ 230Vac	Aac	2.4	4.8	5.1	9.6	10.2	14.4	15.3
AC input cable section	mm ²	3 x 1.5						
AC input cable length	m	1.5						
Max output current @ 230Vac	Adc	36	36	25/18	72	50/36	108	75/54
Battery cables section	mm ²	25						
Battery cables length	m	3						
IP protection		IP21						
Operating temperature	°C	0°C to +45°C						
Power factor		0.99						
Idle mode	W	≤10						
Display		Multiline TFT						
Weight	kg	6.0			7.0		8.0	
Dimensions (HxWxD)	mm	344 x 250 x 182						
Weight with airmix	kg	9.0			10.0		11.0	
Dimensions (HxWxD) with airmix	mm	435 x 286 x 185						
Cabinet		3 bay (1 module)			3 bay (2 modules)		3 bay (3 modules)	

3 bay cabinet

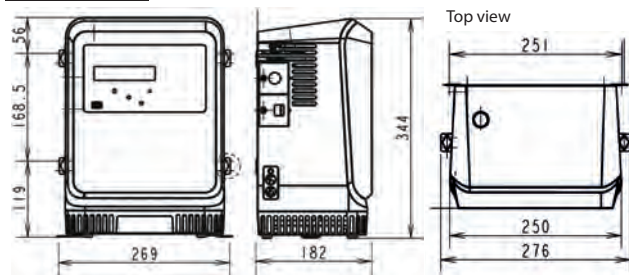

TECHNICAL SPECIFICATION - THREE PHASE

Specifications	Units	3.5kW		7kW		10.5kW		14kW		17.5kW		21kW	
Battery voltage		24/36/48V	72/80V	24/36/48V	72/80V	24/36/48V	72/80V	24/36/48V	72/80V	24/36/48V	72/80V	24/36/48V	72/80V
Nominal input voltage	Vac	400V +/- 10% / 3ph											
Frequency	Hz	50/60											
Max current draw @ 400Vac	Aac	5.6	5.6	11.2	11.2	16.8	16.8	22.4	22.4	28.0	28.0	29.8	33.6
AC input cable section	mm ²	4 x 2.5				4 x 4.0				4 x 6.0			
AC input cable length	m	2											
Max output current @ 400Vac	Adc	70/65/60	40/36	140/130/120	80/72	210/195/180	120/108	280/260/240	160/144	320/320/300	200/180	320/320/320	240/216
Battery cables section	mm ²	35				70				95			
Battery cables length	m	3											
IP protection		IP21											
Operating temperature	°C	0°C to +45°C											
Power factor		0.95											
Idle mode	W	≤10											
Display		Multiline TFT											
Weight	kg	26.0	29.5	33.5	37.0	44.5	48.0						
Dimensions (HxWxD)	mm	508 x 335 x 352						508 x 485 x 352					
Weight with airmix	kg	28.0	31.5	35.5	39.0	46.5	50.0						
Dimensions (HxWxD) with airmix	mm	508 x 335 x 352						508 x 485 x 352					
Cabinet		2 bay (1 module)		2 bay (2 modules)		4 bay (3 modules)		4 bay (4 modules)		6 bay (5 modules)		6 bay (6 modules)	

2 and 4 bay cabinet

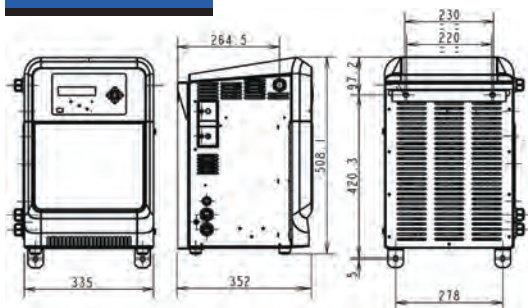



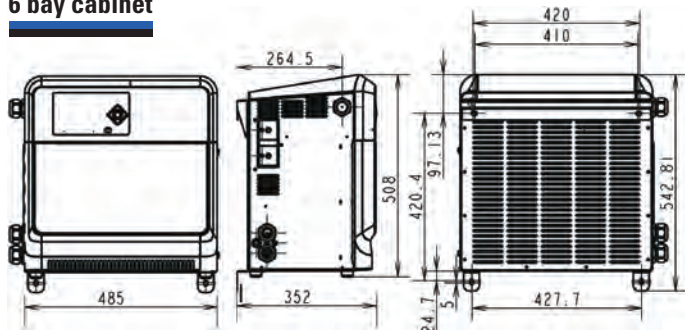











6 bay cabinet



OPTIONS

● available

Option	Description	Lifetech [®]	Life iQ™	Picture (internal equipment)	Picture (external equipment)
Airmix*	To initiate electrolyte circulation in the battery (what shortens the charge duration)	●	●		
Electrovalve*	To allow to fill the battery with water automatically	●	●		
Remote red and green indicators*	To indicate battery in charge/available remotely	●	●		
Remote red and green indicators with on/off switch*	To indicate battery in charge/available and to allow to start/stop the charge remotely	●	●		
BSI 40™*	Battery Status Indicator to indicate first battery to use (FIFO system)	●	●		
	Additional external LCD display	●	●		
	Additional external alarm	●	●		
Arcless (or pilot contact control or LM/EB)*	To remove arcs in the output plug in case of disconnection during the charge (could be 1 or 2 wire(s) option depending on the battery connection)	●	●		
Ethernet	To connect the charger to a network (wired)		●		
Ethernet WIFI	To connect the charger to a network (wireless)		●		
BFM	To connect the charger to BFM system (wired)		●		
PLC	To connect the charger to a Programmable Logic Controller through relays		●		

*not available on 1 kW stand alone

Slot 1 (upper) is used for electrovalve or airmix connection.
 Slot 2 (lower) is used for all other option connection.
 There are no more than two options according to free posts.

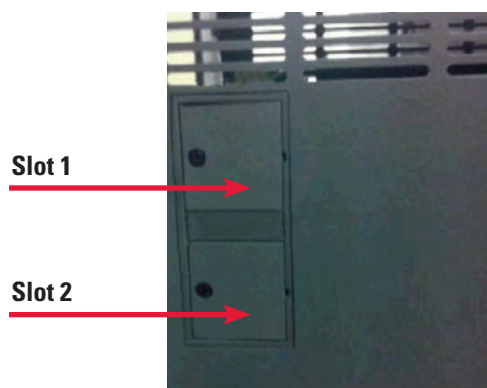



EnerSys EMEA
EH Europe GmbH
Baarerstrasse 18
6300 Zug
Switzerland
Tel: +41 44 215 74 10
Fax: +41 44 215 74 11
www.enersys.com

EnerSys Ltd
Oak Court
Clifton Business Park
Wynne Avenue
Swinton
Manchester M27 8FF
Tel: 0161 794 4611
Fax: 0161 727 3809

© 2016 EnerSys. All rights reserved. All trademarks and logos are the property of or licensed to EnerSys and its affiliates unless otherwise noted.

09.2016 - Subject to revisions without prior notice. E&OE